



iVario®

The Game Changer.

Industry catering.



iVario live

Countless tasks. One iVario.

Looks like a tilting pan, but it can do so much more. The iVario boils, pan-fries, deep-fries and pressure-cooks—which means it replaces tilting pans, boilers, deep-fat fryers and pressure cookers. Even better, it works up to four times faster* than conventional kitchen technology, using up to 40% less energy*. In other words, it does more in less time to ensure efficient production.

Replaces



Tilting pans



Boilers



Deep-fat fryers



Pressure cookers



*Compared to conventional tilting pans, boilers and deep-fat fryers.
For more information, visit rational-online.com.

Benefits to you.

Standardised food quality.

Delicious. On any scale.

The art of industry catering: producing mass quantities with massive appeal. Over and over again. The iVario: meeting every expectation perfectly. By implementing specifications precisely. By handling products optimally. By reacting to even the slightest changes promptly. Nothing sticks, nothing boils over.

Higher output.

Endless production.

Dinner for 300, 3,000 or more? Par for the course in industry catering. The iVario has the speed, the reserve power and the capacity to produce large quantities of food efficiently. Exceptional uniformity, minimal energy consumption and delicious flavours: all in perfect balance.

Save time, space and ingredients.

The iVario can.

Doing things right the first time saves a lot of time and effort. It's also the iVario speciality. Its numerous cooking processes replace conventional commercial kitchen appliances, which saves a lot of space. Its speed saves a lot of time. Its consistent high quality saves a lot of wasted ingredients. In other words, it does everything right.

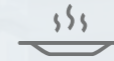
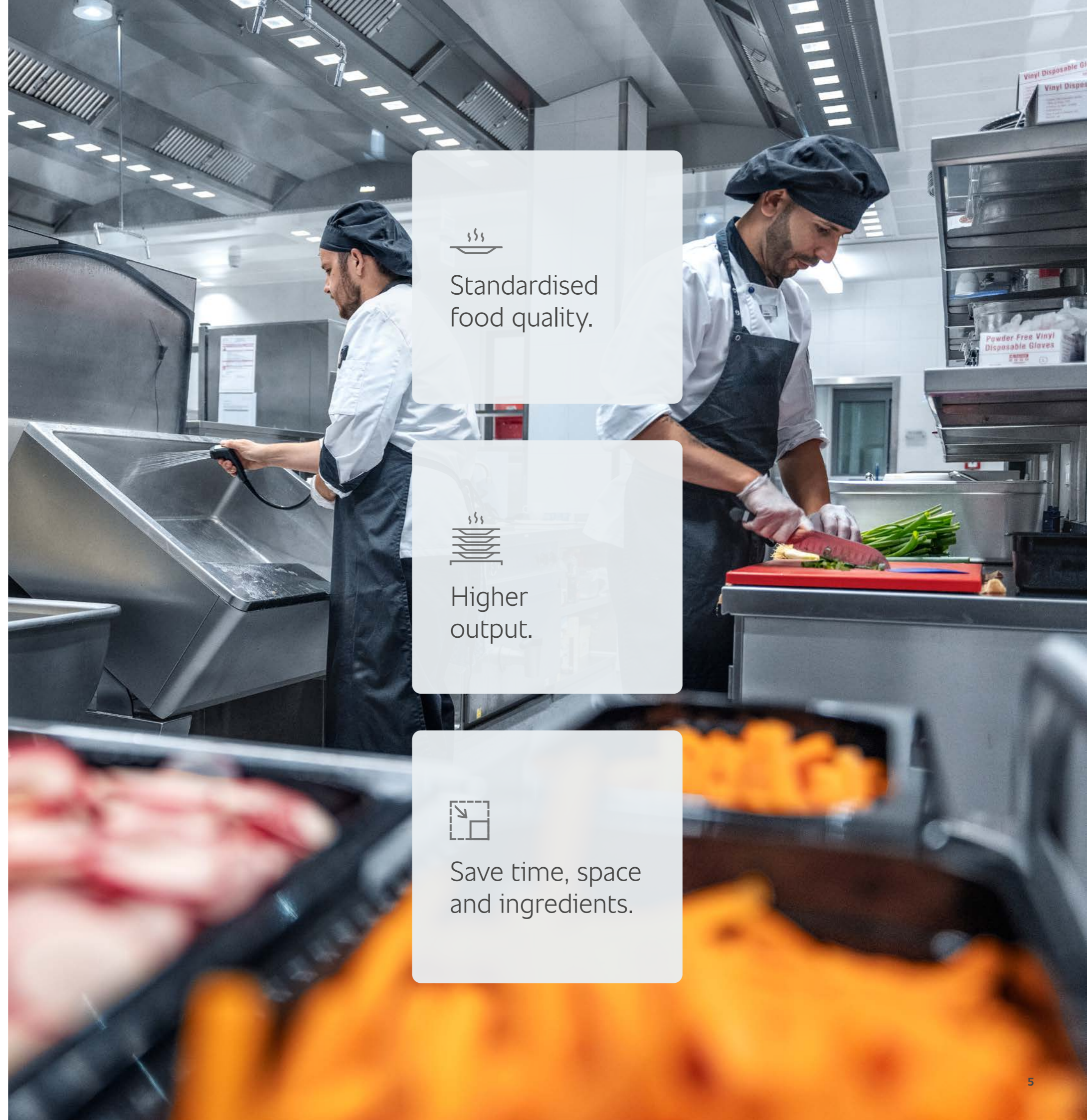

Standardised food quality.



Higher output.



Save time, space and ingredients.

Impressive performance.

Top-quality results.

Lip-smacking, mouth-watering, flavoursome – the iVario delivers all types of delicious food. Quickly and consistently regardless of quantity.

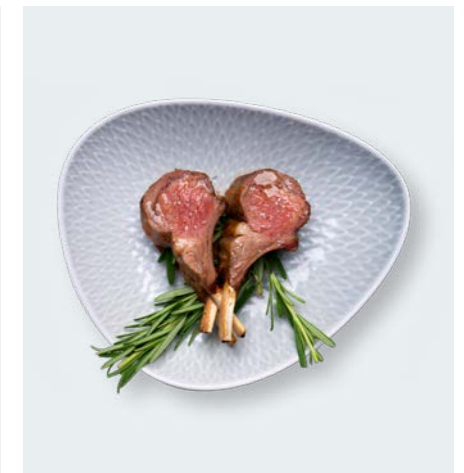
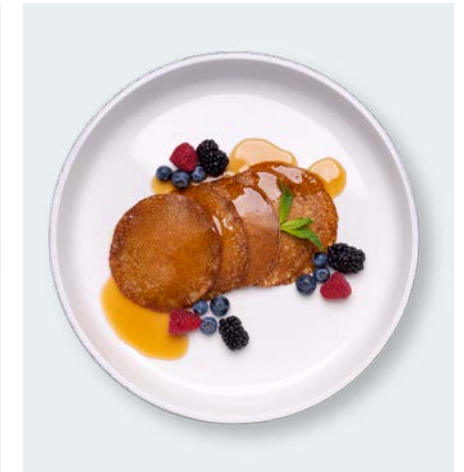
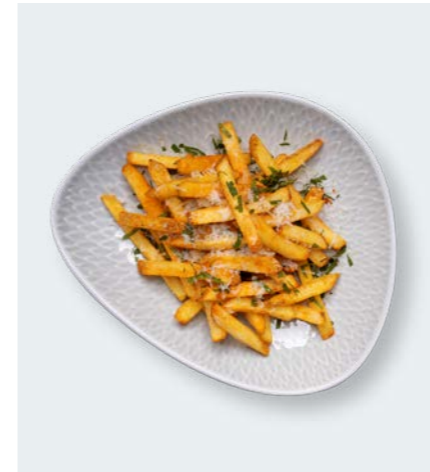
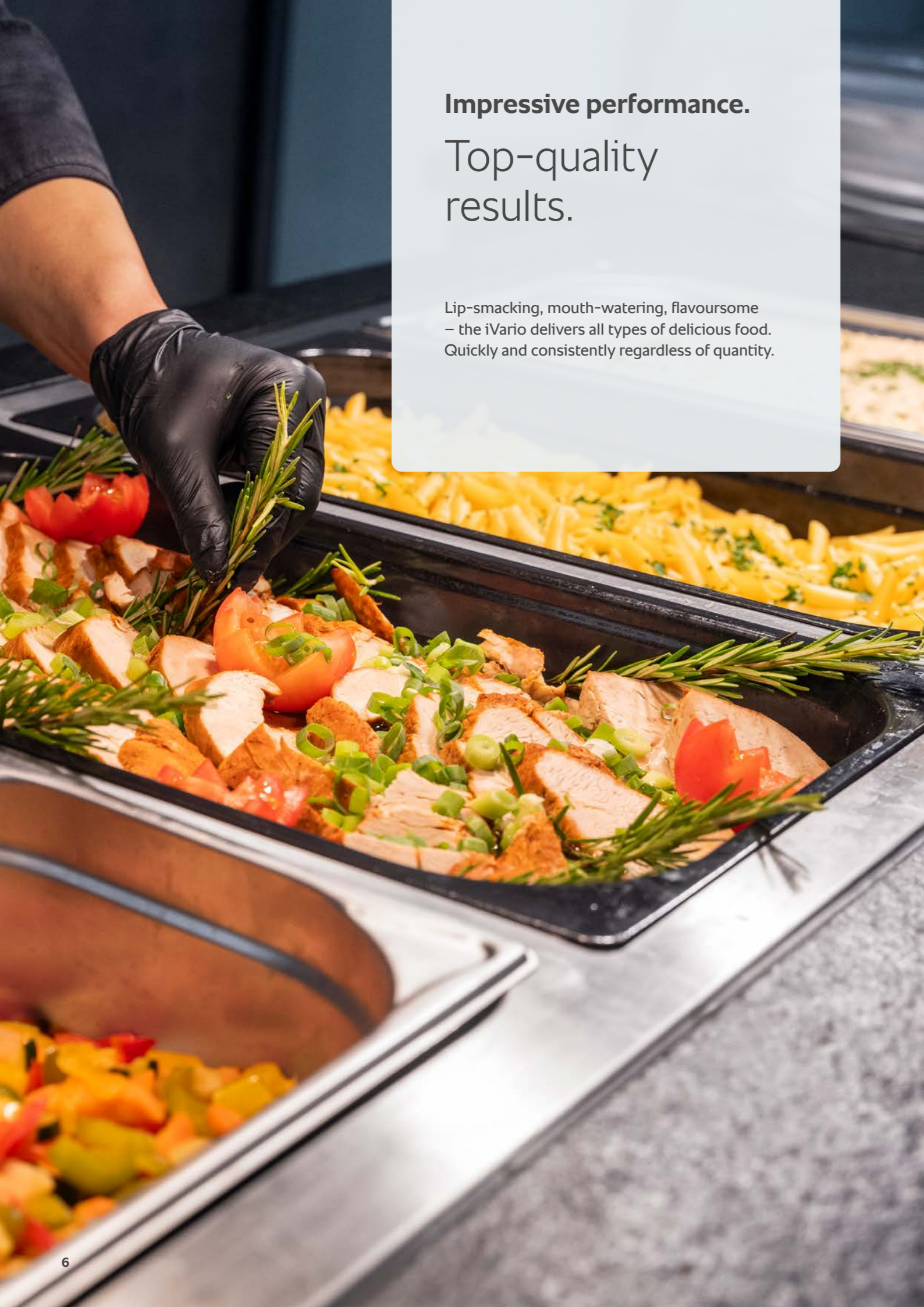

For example*:

- › **Blanching:** 18 kg of broccoli in 23 minutes
- › **Braising:** 1,200 servings of Bolognese sauce in 90 minutes
- › **Boiling:** 400 servings of vegetable soup in 35 minutes
- › **Deep-frying:** 12 kg of battered vegetables in 19 minutes
- › **Boiling:** 15 kg of pasta (in basket) in 22 minutes
- › **Pressure cooking:** 70 kg of braised meat in 120 minutes
- › **Boiling dairy:** 800 servings of rice pudding in 70 minutes
- › **Pan frying:** 100 servings of fried rice in 20 minutes

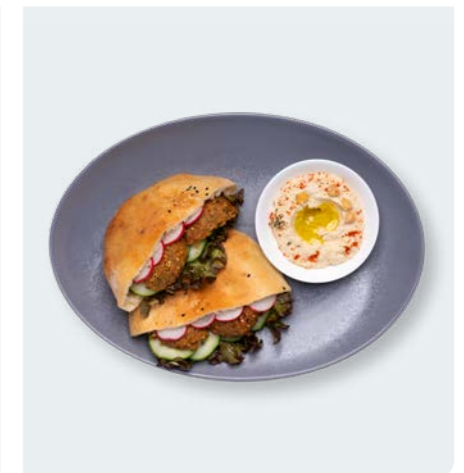

* iVario Pro XL



Speed & precision. Performance management.

Precise. Intelligent. Powerful.
Performance management in the iVario:

- › A winning combination of ceramic heating elements and a highly responsive, scratch-resistant pan base
- › Uniform heat distribution across the entire surface
- › Exceptional speed and efficiency
- › Consumes up to 40% less electricity than conventional appliances
- › Reserve power for large quantities
- › Heats to 200°C in just 2.5 minutes
- › Boils 18 L water in 7.5 minutes

Benefits:



iVarioBoost 

Monitoring and assistance.

The intelligence of the iVario.

Continuously monitors and supports food production in the iVario Pro. At the touch of a button.

- › Easy to operate – almost no orientation required
- › Automatically adjusts cooking processes to fit each dish
- › Delivers your target results every time
- › Only alerts you when you need to do something
- › Networking via ConnectedCooking
- › Practical search assistant

It even works overnight.

To cook overnight, just load the iVario, start the cooking process and then unload the finished food the next morning.

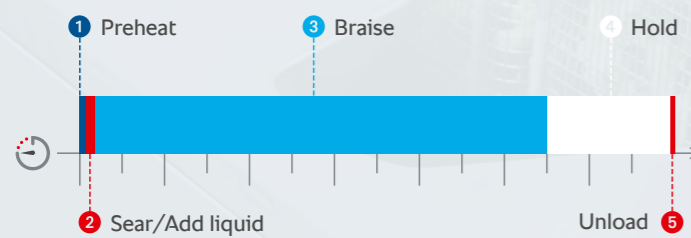

Benefits:



iCookingSuite 



Monitoring and assistance.

Your intelligent assistant in everyday kitchen work.

An operating concept that sets standards: Intuitive display with pre-installed cooking procedures. Touch screen and rotary dial controls allow quick, easy and efficient operation.

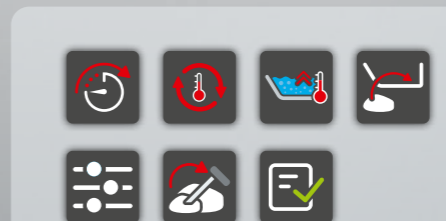
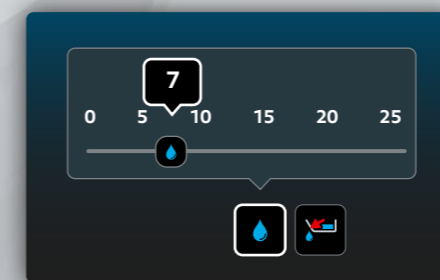
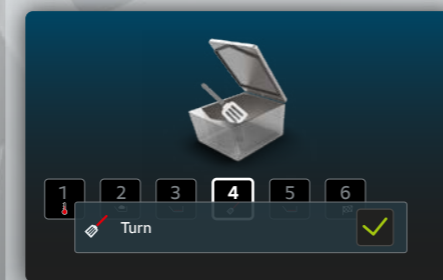
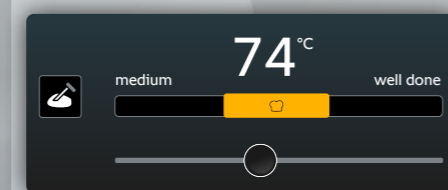
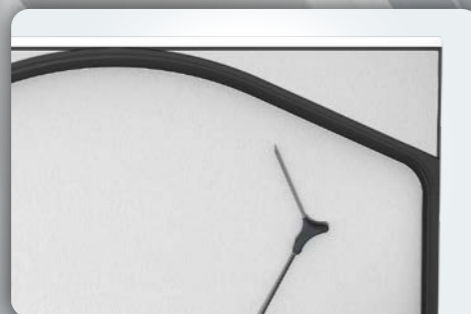
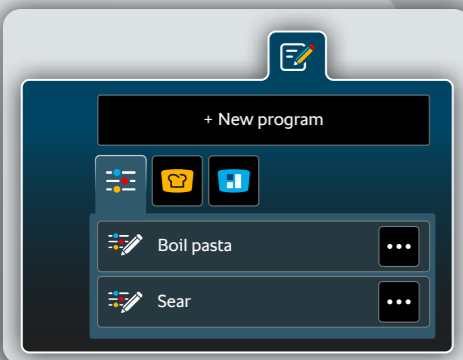
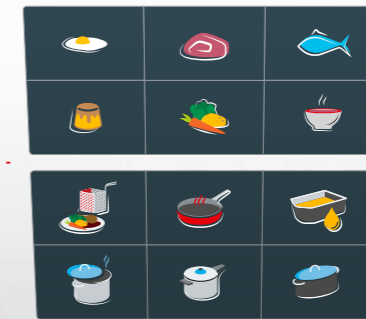

Preset, custom or manual cooking processes – the programming functions make it possible to tailor to individual work processes.

With MyDisplay, the user interface can be adapted so that only the functions that are currently required are displayed.

The integrated core probe's six measurement points detect product sizes and quantities, so every dish reaches the set core temperature – and the target results – precisely.

Intelligent regulation and interactive communication with the iVario cooking intelligence. Which adjusts cooking processes individually to each dish, adapts to users' habits and alerts them when something needs doing.

Automatic water inlet. At the touch of a button, measured to the exact litre. Whenever you need it. With integrated drain.

Decide on the next steps – continue cooking, boil down, hold or start a new load. These options can be selected as required while the cooking system is in operation. This makes handling simple and ensures food quality.

Preset, custom or manual cooking processes – the programming functions make it possible to tailor to individual work processes.

With MyDisplay, the user interface can be adapted so that only the functions that are currently required are displayed.



Pressure cooking.

Builds up pressure to take the pressure off.

The optional intelligent pressure-cooking function kicks things into even higher gear*:

- > Soups, stews, casseroles, braised dishes and legumes cook up to 46% faster
- > Easy and safe to use
- > No loss of quality
- > Faster pressure build-up and release
- > No additional maintenance required (e.g., annual pressure inspections)

Shorter cooking times

Example: 68 kg casserole in the iVario Pro XL.



	Cooking	Pressure cooking
Vegetable soup	72 min.	48 min. ⚡ 33%
Chickpeas	65 min.	42 min. ⚡ 35%
Potatoes	43 min.	34 min. ⚡ 21%

Benefits:

Multifaceted and flexible.

Turn one into many.

Use iZoneControl to turn a single iVario into up to four zones. For a more diverse and energy-efficient kitchen.

- › Divide the pan base into up to four zones
- › Flexibility in zone size, position and shape
- › Prepare different dishes in a single pan
- › Simultaneously or time-delayed, at the same or different temperatures
- › Heat only the surfaces needed



Benefits:



iZoneControl





- ① iVario integrated into kitchen block
- ② Plinth set-up
- ③ Wall mounting
- ④ iVario with substructure and feet

IP X5

Setup variations.

Always the right solution.

Whether you are installing a new kitchen or enhancing an existing one, the iVario adapts to any surroundings.

- > Can be installed on top of work surfaces or tables, against walls or integrated into kitchen blocks
- > No floor drain required thanks to integrated water drain
- > No slippery floors – greater work safety



Challenging kitchen space.

Less is more.

Fewer appliances, more space to work.
Do more in less time. Only the iVario offers that combination.

- › Replaces tilting pans, boilers, deep-fat fryers and pressure cookers
- › Saves up to 33% more space
- › More efficient than conventional kitchen technology
- › Without compromising on food quality

Benefits:



Benefits:



Space saving

Kitchen composition
Before

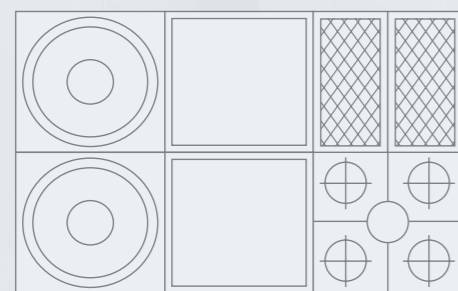

- 1 × stove
- 2 × boiler
- 2 × tilting pan
- 1 × deep-fat fryer

Kitchen composition
Now

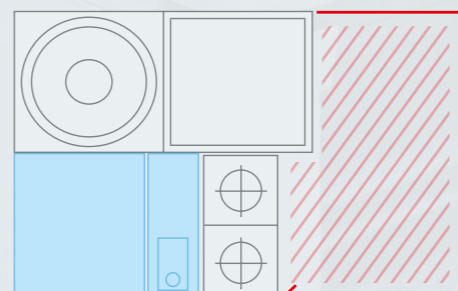

- 1 × stove
- 1 × boiler
- 1 × tilting pan
- 1 × iVario Pro L

33 %
space savings

Time savings

Cook
Pasta

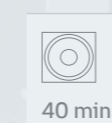

40 min

Pan-fry/Braise
Poultry ragout

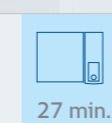

69 min.

Deep-frying
Chips



28 min.

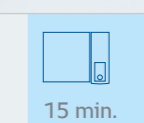

15 min.

13 min.

13 min.

49 min.

Modern working. Easier than ever.

The iVario makes kitchens ergonomic,
labour-saving and efficient.

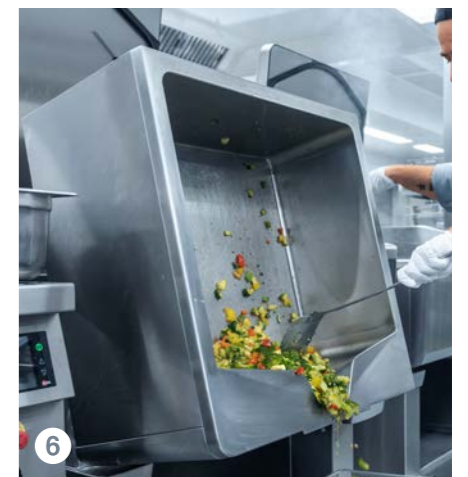
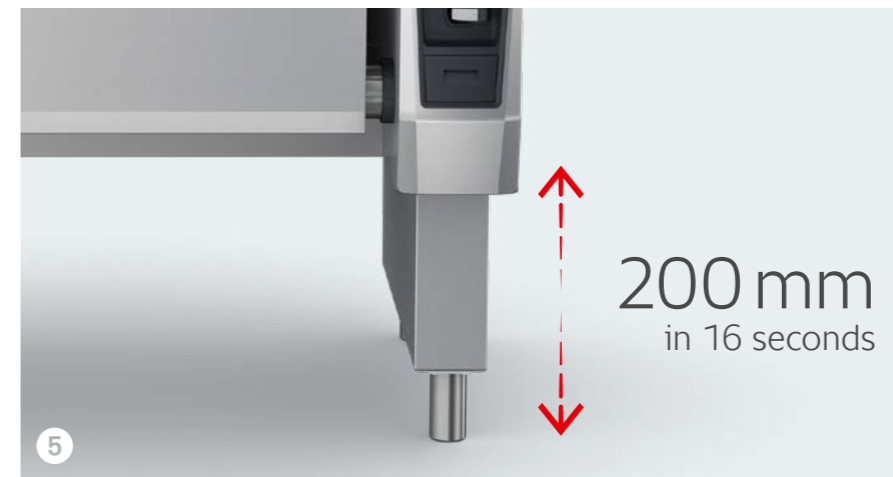
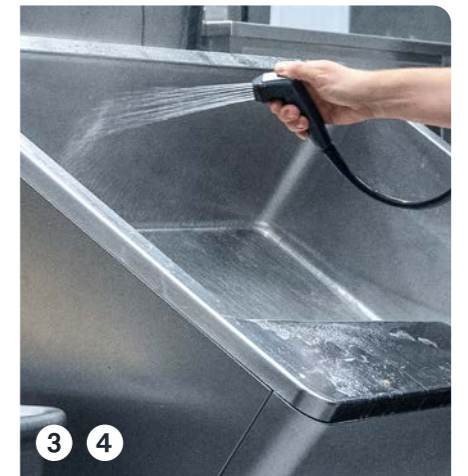
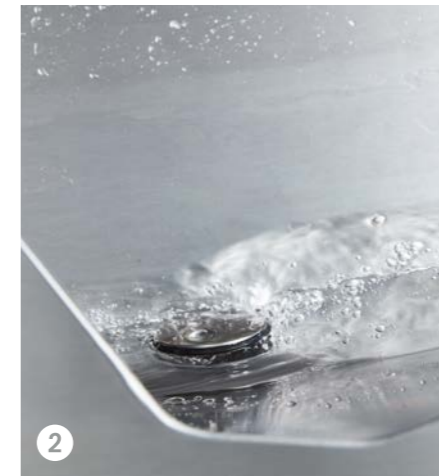

- ❶ Automatic water inlet
- ❷ Integrated drain
- ❸ Quick and easy cleaning
- ❹ Cool pan edges and rounded corners
- ❺ Height adjustment (option)
- ❻ Easy, safe emptying
- ❼ Clear, intuitive touch screen controls
- ❽ AutoLift (automatic lifting and lowering function)
- ❾ WiFi (option) for networking
- ❿ Integrated hand shower (option)
- ⓫ Integrated socket (adapted to local standards)



Accessories.

Get there faster.

Industry catering operations need durable tools that make operators work easier and deliver ideal results. They need RATIONAL original accessories.

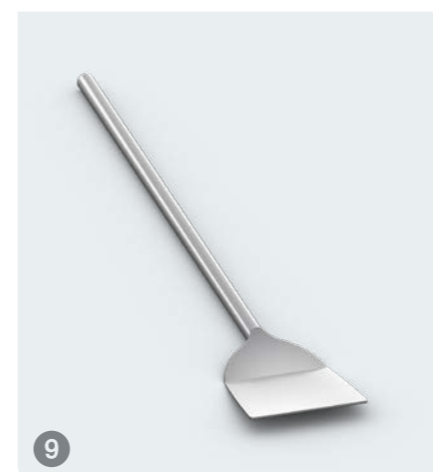

- ① VarioMobil
- ② Cleaning sponge
- ③ Sieve
- ④ Unpunched scoop
- ⑤ Punched scoop
- ⑥ Boiling basket
- ⑦ Deep-frying basket
- ⑧ Oil cart
- ⑨ Long spatula



More information

RATIONAL Services.

Here's to a beautiful partnership.

RATIONAL after-sales services. Ensuring your investment pays off long term, so that you always get the most out of your cooking systems and you never run out of ideas.

- › Installation by certified Service Partners
- › Unit Introduction
- › Free software updates
- › ChefLine, the free RATIONAL hotline
- › RATIONAL Academy

Economy.

Let's do the maths together.

What makes a kitchen successful? When the investments pay off. Here's how the iCombi Pro does it:

- › Ready for immediate use
- › Replaces numerous kitchen appliances
- › Makes additional investments unnecessary
- › Saves time, space, ingredients, electricity and water
- › Extremely short ROI time

Your profit	Calculation approach per year	ROI time under one year	Your additional earnings per year	Do the calculation for yourself
Meat				
With up to 10% less consumption of raw materials for daily specials (diced meat, casserole) thanks to the iVarioBoost searing power. Overnight cooking reduces raw materials usage on braised dishes by up to 10%*.	Cost of goods with conventional stoves, tilting pans and boiling pans		49,500 €	= 4,950 €
	Cost of goods with the iVario		44,550 €	
Energy				
Average saving of 68 kWh per service thanks to the sophisticated efficiency of the iVarioBoost heating system*.	68 kWh × 2 services × 5 days × 50 weeks × 0.25 € per kWh			= 8,500 €
Working time				
Average saving of 120 minutes per day per unit thanks to the power and speed of the iVarioBoost heating system, automatic boiling with the iCookingSuite and thanks to overnight cooking.	1,000 hours × 25 € (Compound calculation based on an hourly rate for chef/cleaning staff)			= 25,000 €
Cleaning				
Average yearly savings on water and detergent*. No more soaking tilting pans or boilers.	600 litres of water per service × 3.00 €/m ³ plus 50 litres of detergent per year			= 980 €
Your extra earnings per year				= 39,430 €

Average catering establishment with 600 meals per day (2 services) using one iVario Pro L and XL, additional earnings compared to operating with a tilting pan, boiler and deep-fat fryer.

* Compared to conventional tilting pans, boilers and deep-fat fryers.

Our standard.

Sustainable product quality.

Robust, solid, ready for everyday use – those are our expectations on every cooking system. Product quality benefits, of course, but so does sustainability:

- › Longer life cycle thanks to meticulous production
- › High standard of quality, high reparability
- › Large quotient of recyclable materials
- › Ergonomic work
- › Easier work thanks to digitisation



iVario overview of models.

Which model is the right one for you?



- 1 Base unit integrated into kitchen block
- 2 Plinth set-up
- 3 Wall mounting
- 4 Base unit with substructure and feet

IP X5

iVario	2-XS	Pro 2-S	Pro L	Pro XL
Number of meals	from 30	50 - 100	100 - 300	100 - 500
Effective volume	2 × 17 litres	2 × 25 litres	100 litres	150 litres
Cooking surface area	2 × 2/3 GN (2 × 13 dm ²)	2 × 1/1 GN (2 × 19 dm ²)	2/1 GN (39 dm ²)	3/1 GN (59 dm ²)
Width	1100 mm	1100 mm	1030 mm	1365 mm
Depth	756 mm	938 mm	894 mm	894 mm
Height (including stand/substructure)	485 (1080) mm	485 (1080) mm	608 (1078) mm	608 (1078) mm
Weight	117 kg	134 kg	196 kg	236 kg
Water inlet	R 3/4"	R 3/4"	R 3/4"	R 3/4"
Drain	DN 40	DN 40	DN 50	DN 50
Connected load (3 NAC 400V) Standard/Balanced Power	14 kW	21 kW	27 kW / 21 kW	41 kW / 34 kW
Fuse (3 NAC 400V) Standard/Balanced Power	20 A	32 A	40 A / 32 A	63 A / 50 A
Options				
Pressure cooking	–	◦	◦	◦
iZoneControl	◦	•	•	•
Low temperature cooking (overnight, sous vide, confit)	◦	•	•	•
WiFi	◦	•	•	•

Performance examples (per pan)

	2-XS	Pro 2-S	Pro L	Pro XL
Searing meat for casserole	4.5 kg	7 kg	15 kg	24 kg
Cooking time	5 min	5 min	5 min	5 min
Cook goulash (meat and sauce)	17 kg	25 kg	80 kg	120 kg
Cooking time without pressure	188 min	188 min	188 min	188 min
Cooking time with pressure	–	102 min	102 min	102 min
		↓ -46%	↓ -46%	↓ -46%
Chickpeas, soaked	4 kg	7 kg	20 kg	30 kg
Cooking time without pressure	65 minutes	65 minutes	65 minutes	65 minutes
Cooking time with pressure	–	42 min	42 min	42 min
		↓ -35%	↓ -35%	↓ -35%
Jacket potatoes	7 kg	12 kg	45 kg	65 kg
Cooking time without pressure	43 min	43 min	43 min	43 min
Cooking time with pressure	–	34 min	34 min	34 min
		↓ -21%	↓ -21%	↓ -21%

• Standard ◦ optional – not available

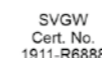

iVario live

Cook with our experts.

Nothing's more convincing than first-hand knowledge. Experience the RATIONAL cooking systems in use, see the functions for yourself and try out to see how you can work with them. Live, with no obligation and at a location near you.



Register now

+41 71 727 9090

info@rational-online.com

RATIONAL International AG

Heinrich-Wild-Strasse 202
9435 Heerbrugg
Switzerland

Tel. +41 71 727 9090

Fax +41 71 727 9080

info@rational-online.com
rational-online.com

